

3 Port PM Fiber Circulator (850nm)

Features:

Low Insertion Loss
 High Extinction Ratio and High Isolation
 High stability and reliability

Application:

Fiber Laser
 Fiber Optical Instrument

Specifications:
Specifications

Center Wavelength	nm	850
Operating Wavelength Range	nm	±10
Max. Isolation at 23°C	dB	22
Max. Insertion Loss at 23°C	dB	1.5
Min PER at 23°C,	dB	20
Min. Return Loss(Input/ Output)	dB	45
Min. Cross Talk	dB	45
Max. Average Optical Power	MW	300
Max. Tensile Load	N	5
Fiber		PM780
Package Dimension	mm	62x32x28
Operating Temperature	°C	+10~+50
Storage Temperature	°C	0~+60

*Above specifications are for devices without the connectors.

*For devices with connectors, IL will be 0.3dB higher, RL will be 5dB lower

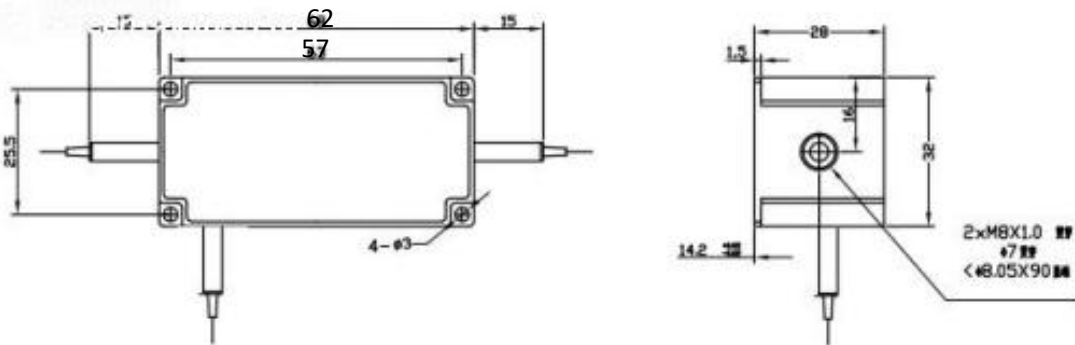
Packing Dimensions:

Ordering Information

PM CIR	Wavelength	00000	Pigtail Type	Length	Connector
	850=850		1=900u m loose tube	H=0.5m 8=0.8m 1=1.0m S=others	0=None 1=FC/UPC 2=FC/APC