

850nm Polarization Insensitive Isolator

Features:

Low Insertion Loss High Isolation & Return Loss
 High reliability

Application:

Fiber Laser

Specifications:

Parameter	Value
Center wavelength (nm)	850
Bandwidth (nm)	±10
Insertion Loss @23°C	≤1.5
Isolation at 23°C(dB)	≥22
PDL(dB)	≤0.15
Return loss (Input/output) (dB)	≥50/50
Optical power (W)	0.3-1
Fiber Type	HP780
Operating temperature (°C)	0 ~ +65
Storage temperature (°C)	-20 ~ +85
Package Dimension LxWxH (mm)	62x32x28

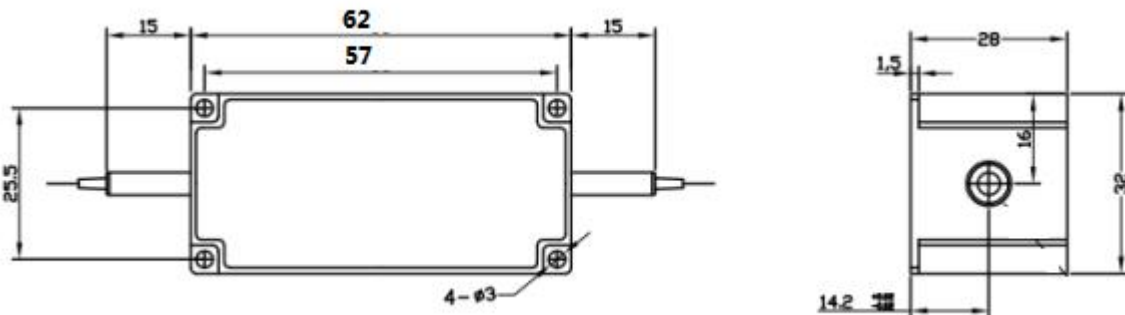
Package dimension:

Ordering Information:

HPIIS	Wavelength	Power	00	Pigtail Type	Length	Connector
HPIIS	850=850	03=300mW 01=1W		2=900um loose tube	H=0.5m 7=0.7m 1=1.0m S=Specify	0=None 1=FC/UPC 2=FC/APC 6=Specify