

## 3 Port Polarization Insensitive Circulator (850nm)

**Features:**

Low Insertion Loss  
 High Extinction Ratio and High Isolation  
 High stability and reliability

**Application:**

Fiber Laser  
 Fiber Optical Instrument

**Specifications:**
**Specifications**

Center Wavelength	nm	850
Operating Wavelength Range	nm	±5
Max. Isolation at 23°C	dB	22
Max. Insertion Loss at 23°C	dB	1.5
Min. PDL at 23°C,	dB	0.15
Min. Return Loss(Input/ Output)	dB	45
Min. Cross Talk	dB	45
Max. Average Optical Power	MW	300
Max. Tensile Load	N	5
Fiber		HP780
Package Dimension	mm	60x32x28
Operating Temperature	°C	+10~+50
Storage Temperature	°C	0~+60

\*Above specifications are for devices without the connectors.

\*For devices with connectors, IL will be 0.3dB higher, RL will be 5dB lower

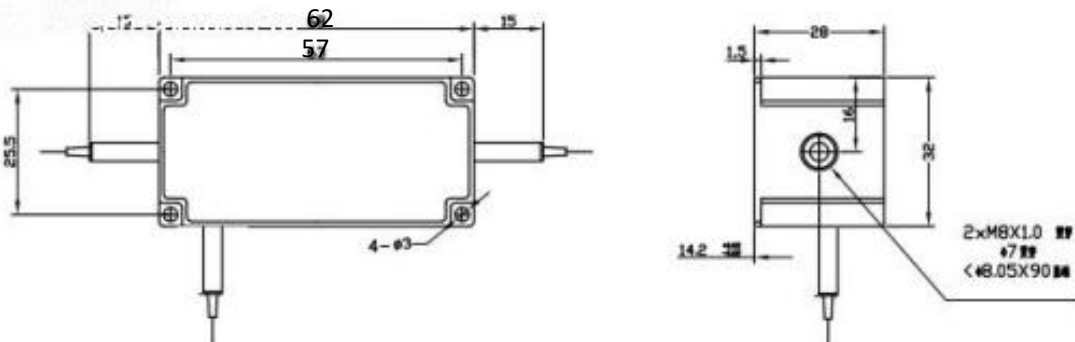
**Packing Dimensions:**

**Ordering Information**

FCIR	Wavelength	00000	Pigtail Type	Length	Connector
	850=850		1=900u m loose tube	H=0.5m 8=0.8m 1=1.0m S=others	0=None 1=FC/UPC 2=FC/APC